

RF & MICROWAVE TRANSISTORS GENERAL PURPOSE AMPLIFIER APPLICATIONS

- EMITTER BALLASTED
- REFRACTORY/GOLD METALLIZATION
- VSWR CAPABILITY $\infty:1$ @ RATED CONDITIONS
- HERMETIC STRIPAC® PACKAGE
- $P_{OUT} = 1.0$ W MIN. WITH 7.0 dB GAIN @ 2.0 GHz

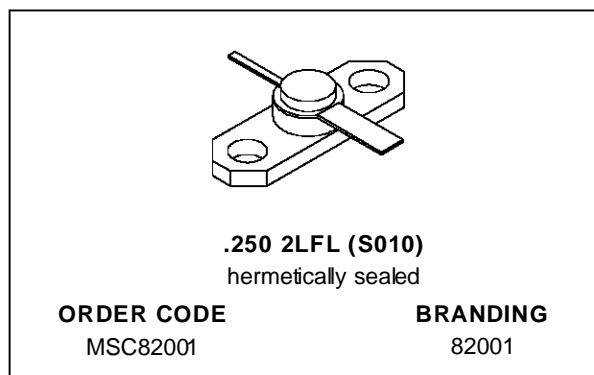

DESCRIPTION

The MSC82001 is a common base hermetically sealed silicon NPN microwave transistor utilizing a fishbone emitter ballasted geometry with a refractory/gold metallization system. This device is capable of withstanding an infinite load VSWR at any phase angle under rated conditions. The MSC82001 was designed for Class C amplifier applications in the 1.0 - 2.0 GHz frequency range.

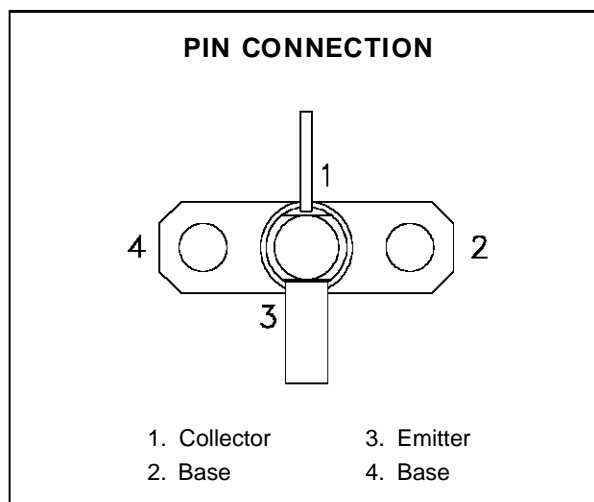

ABSOLUTE MAXIMUM RATINGS ($T_{case} = 25^{\circ}C$)

Symbol	Parameter	Value	Unit
P_{DISS}	Power Dissipation*	7.0	W
I_C	Device Current*	200	mA
V_{CC}	Collector-Supply Voltage*	35	V
T_J	Junction Temperature	200	$^{\circ}C$
T_{STG}	Storage Temperature	- 65 to +200	$^{\circ}C$

THERMAL DATA

$R_{TH(j-c)}$	Junction-Case Thermal Resistance*	20	$^{\circ}C/W$
---------------	-----------------------------------	----	---------------

*Applies only to rated RF amplifier operation

MSC82001

ELECTRICAL SPECIFICATIONS ($T_{case} = 25^{\circ}C$)

STATIC

Symbol	Test Conditions		Value			Unit
			Min.	Typ.	Max.	
BV_{CBO}	$I_C = 1mA$	$I_E = 0mA$	45	—	—	V
BV_{EBO}	$I_E = 1mA$	$I_C = 0mA$	3.5	—	—	V
BV_{CER}	$I_C = 5mA$	$R_{BE} = 10\Omega$	45	—	—	V
I_{CBO}	$V_{CB} = 28V$		—	—	0.5	mA
h_{FE}	$V_{CE} = 5V$	$I_C = 100mA$	15	—	120	—

DYNAMIC

Symbol	Test Conditions			Value			Unit
				Min.	Typ.	Max.	
P_{OUT}	$f = 2.0 GHz$	$P_{IN} = 0.2 W$	$V_{CC} = 28 V$	1.0	1.2	—	W
η_c	$f = 2.0 GHz$	$P_{IN} = 0.2 W$	$V_{CC} = 28 V$	35	40	—	%
G_P	$f = 2.0 GHz$	$P_{IN} = 0.2 W$	$V_{CC} = 28 V$	7.0	7.8	—	dB
C_{OB}	$f = 1 MHz$	$V_{CB} = 28 V$		—	—	3.2	pF

TYPICAL PERFORMANCE

POWER OUTPUT vs FREQUENCY

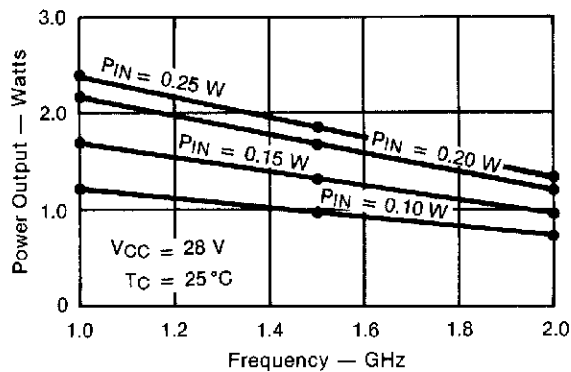

COLLECTOR EFFICIENCY vs FREQUENCY

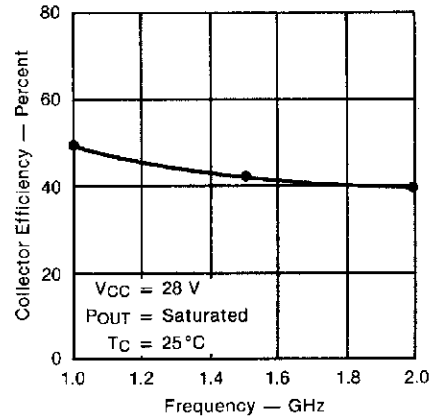

RELATIVE POWER OUTPUT vs COLLECTOR VOLTAGE

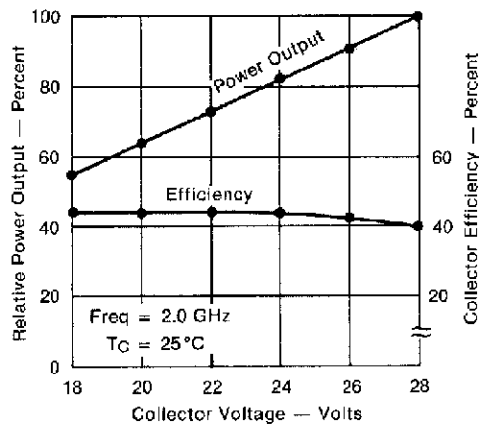

IMPEDANCE DATA

TYPICAL INPUT IMPEDANCE

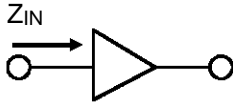

$P_{IN} = 0.2 \text{ W}$
 $V_{CC} = 28 \text{ V}$
 Normalized to 50 ohms

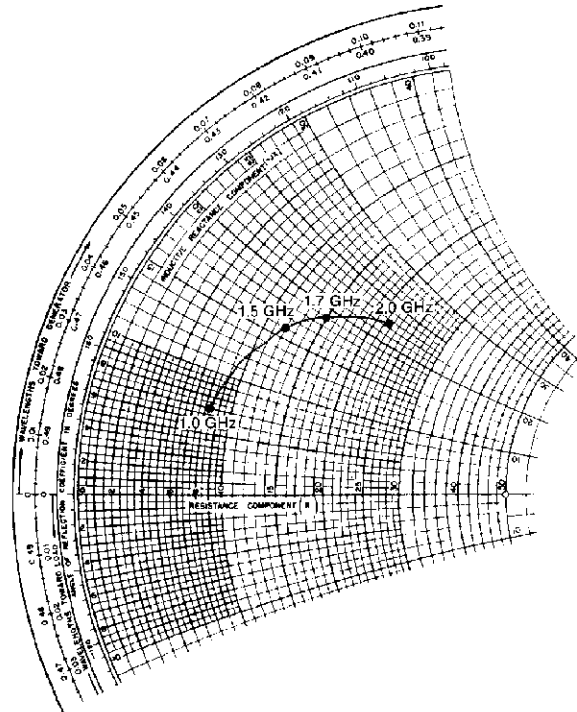

FREQ.	$Z_{IN} (\Omega)$	$Z_{CL} (\Omega)$
1.0 GHz	$8.3 + j 7.0$	$18.0 + j 38.0$
1.5 GHz	$12.0 + j 16.0$	$9.6 + j 30.0$
1.7 GHz	$15.0 + j 14.0$	$7.0 + j 22.0$
2.0 GHz	$21.5 + j 22.5$	$5.0 + j 12.0$

TYPICAL COLLECTOR LOAD IMPEDANCE

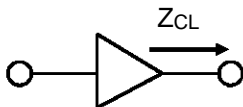

$P_{OUT} = \text{Saturated}$
 $V_{CC} = 28 \text{ V}$
 Normalized to 50 ohms

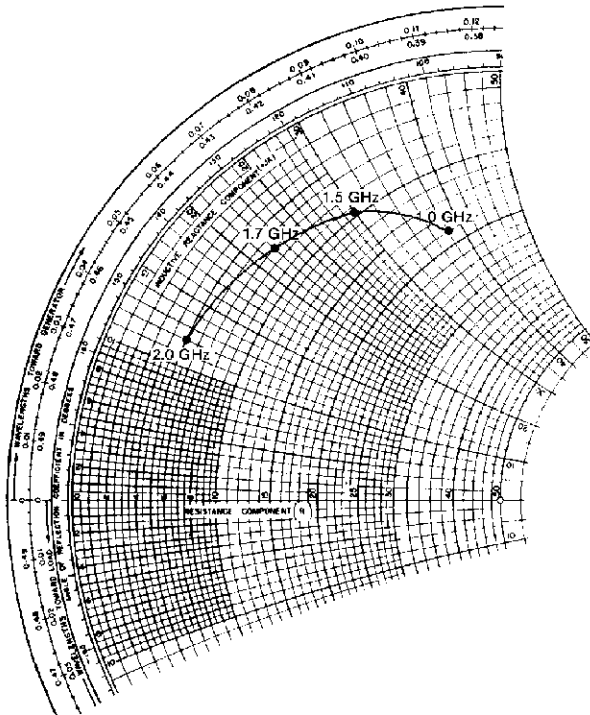

TEST CIRCUIT

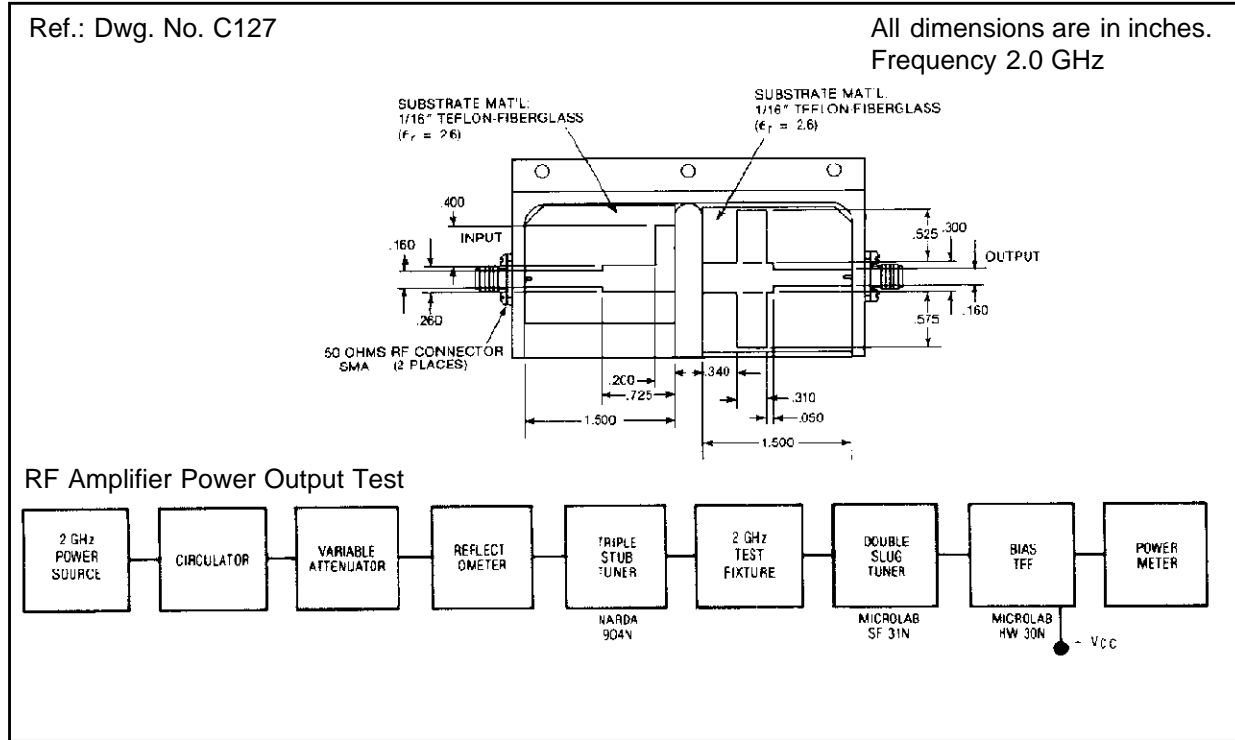

PACKAGE MECHANICAL DATA

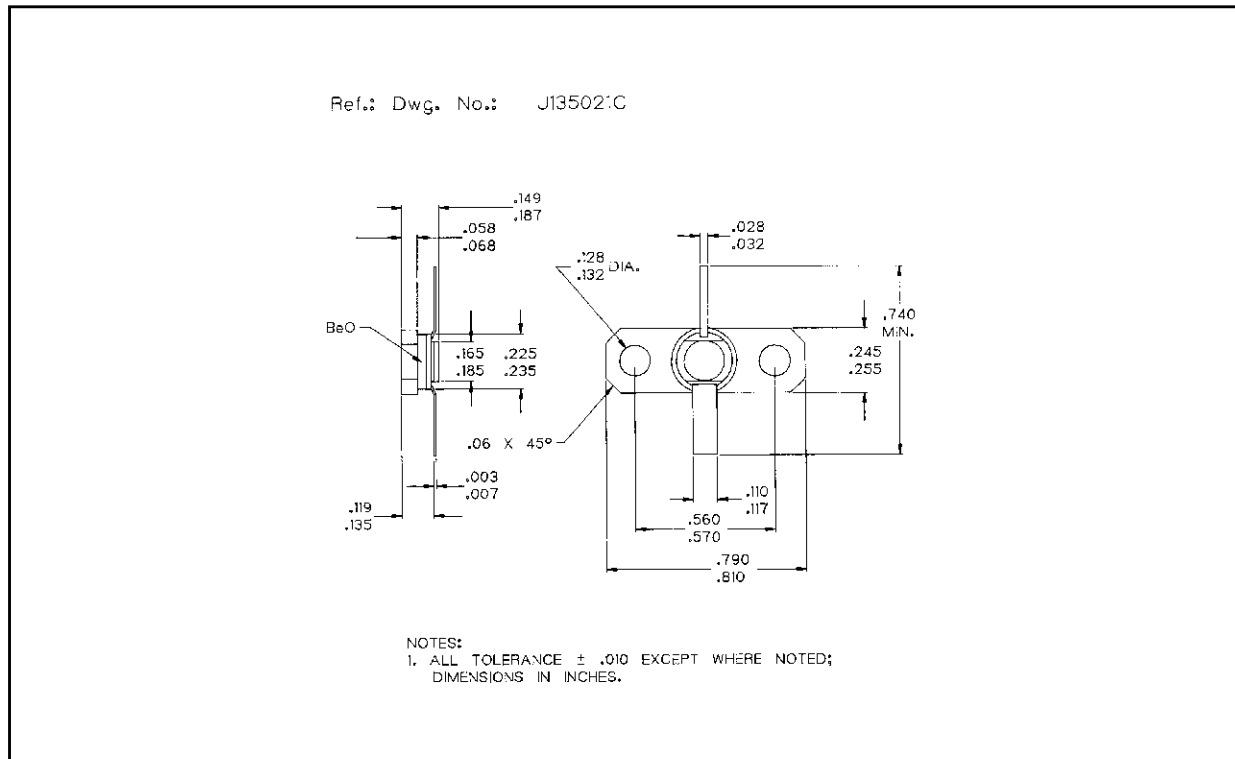

Information furnished is believed to be accurate and reliable. However, SGS-THOMSON Microelectronics assumes no responsibility for the consequences of use of such information nor for any infringement of patents or other rights of third parties which may result from its use. No license is granted by implication or otherwise under any patent or patent rights of SGS-THOMSON Microelectronics. Specifications mentioned in this publication are subject to change without notice. This publication supersedes and replaces all information previously supplied. SGS-THOMSON Microelectronics products are not authorized for use as critical components in life support devices or systems without express written approval of SGS-THOMSON Microelectronics.

© 1994 SGS-THOMSON Microelectronics - All Rights Reserved

SGS-THOMSON Microelectronics GROUP OF COMPANIES

Australia - Brazil - France - Germany - Hong Kong - Italy - Japan - Korea - Malaysia - Malta - Morocco - The Netherlands -
Singapore - Spain - Sweden - Switzerland - Taiwan - Thailand - United Kingdom - U.S.A